

**ZONA 2 - STRADA BRAZILOR - BLOCURI 10, 11, 16  
CF 85458**

**LEGENDA:**

● **Tablouri de distribuție iluminat public, cu rezistența de preincalzire, echipate cu puncte de aprindere și echipament TVCI + motor 50M/GPRS în cutie metalică IP65, IK10, cu închidere cu Yalla, pe postament de beton.**

● **Camera video Camera Speed Dome IP HighVision AcuSense, 2MP Full HD, IR, 100m, Zoom optic 15x, Digital 16x, DS-2DE4213W-DE/TS, cu montaj pe consola prinșă de stalpii de iluminat**

● **Model propus corp de iluminat pentru punerea în valoare a vegetației mature de tip arbori**  
- Specificații corp iluminat: Performance in Lighting  
OR/C/CE1- 15 A/M 3118701 - 3 LED - 2700 K (CRI 90)  
220/240 V-50/60 Hz - IP67 - CLASS I - INOX, Ø=14 W,  
TK09 153 x7, 588lm (sau similar)

● **Model propus corp de iluminat pentru zona pietonală**  
- Specificații corp iluminat: Performance in Lighting  
SPILLO 303814 - 28 LED - 4000 K (CRI 70) 220/240  
V-50/60 Hz - IP66 - CLASS II -  
GRAPHITE/ALUMINIUM, Ø=44 W, TK10 201 x7,  
390lm (sau similar)  
- Specificații stâlp: Gevis URBAN [03] - CONICAL  
POLES PAINTED - 4 m - GRAPHITE GREY (sau similar)

● **Model propus corp de iluminat pentru zona de acces la stațiile autostrazii**  
- Specificații corp iluminat:  
Putere Lampa Led: 12w / 1440lm  
Panou Solar: Monocristalin 50W  
Baterie Solară: Deep Cycle 12V 60AH  
(sau similar)  
- Specificații stâlp: Gevis URBAN [03] - CONICAL  
POLES PAINTED - 4 m - GRAPHITE GREY (sau similar)

- Electrovalva master
- Electrovalve aspersie
- Electrovalve picurare
- Panou comanda
- Senzor ploaie
- SA Sursa Apa

● **Corp de iluminat ornamental - confecție metalică, confecționat din lemn otel vopsit cu 5 corpuri de iluminat stradale KYRO+1 SR/075 3105293 36W, 4799lm, 133 lm/W, 3000°K**

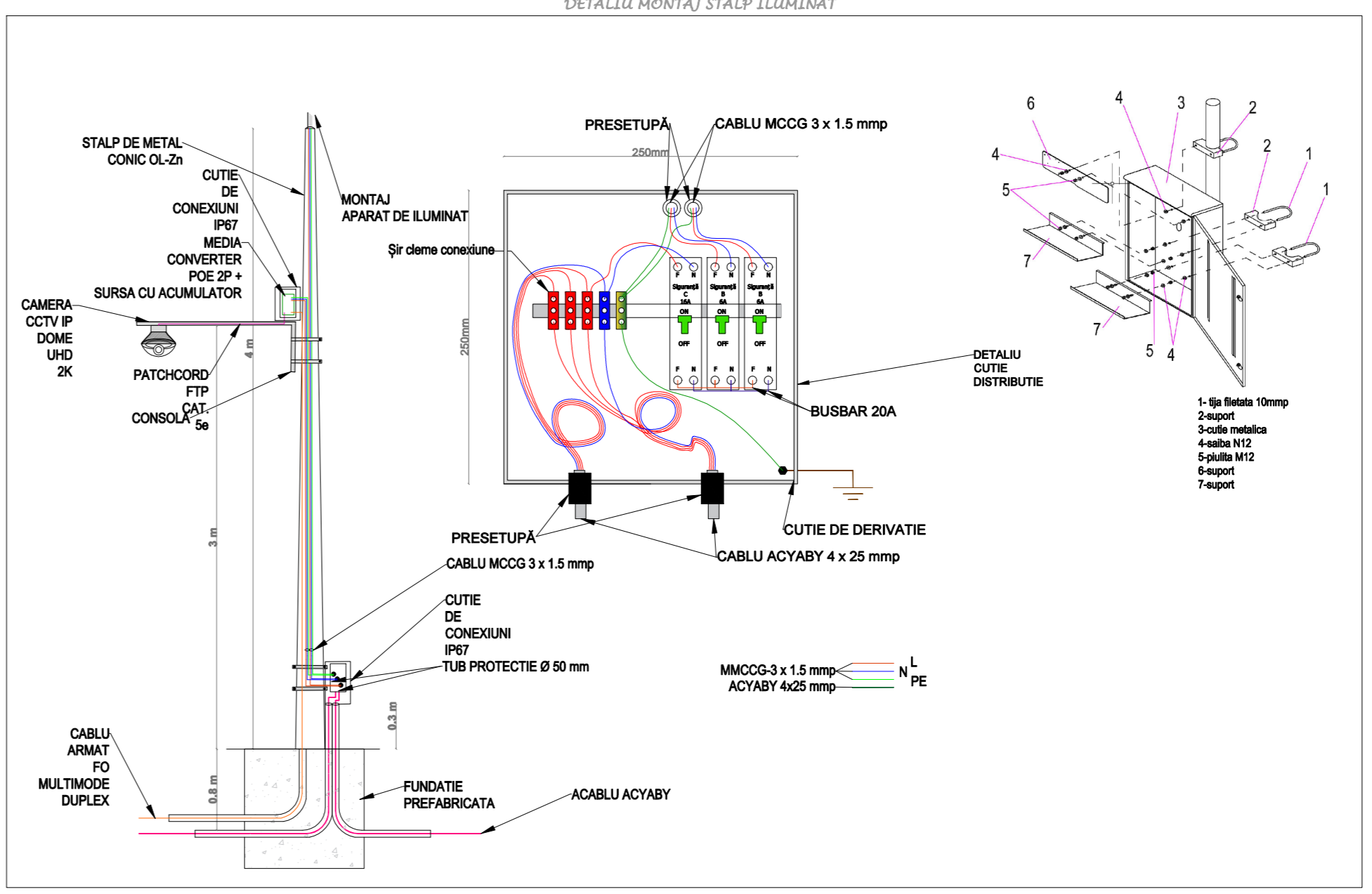
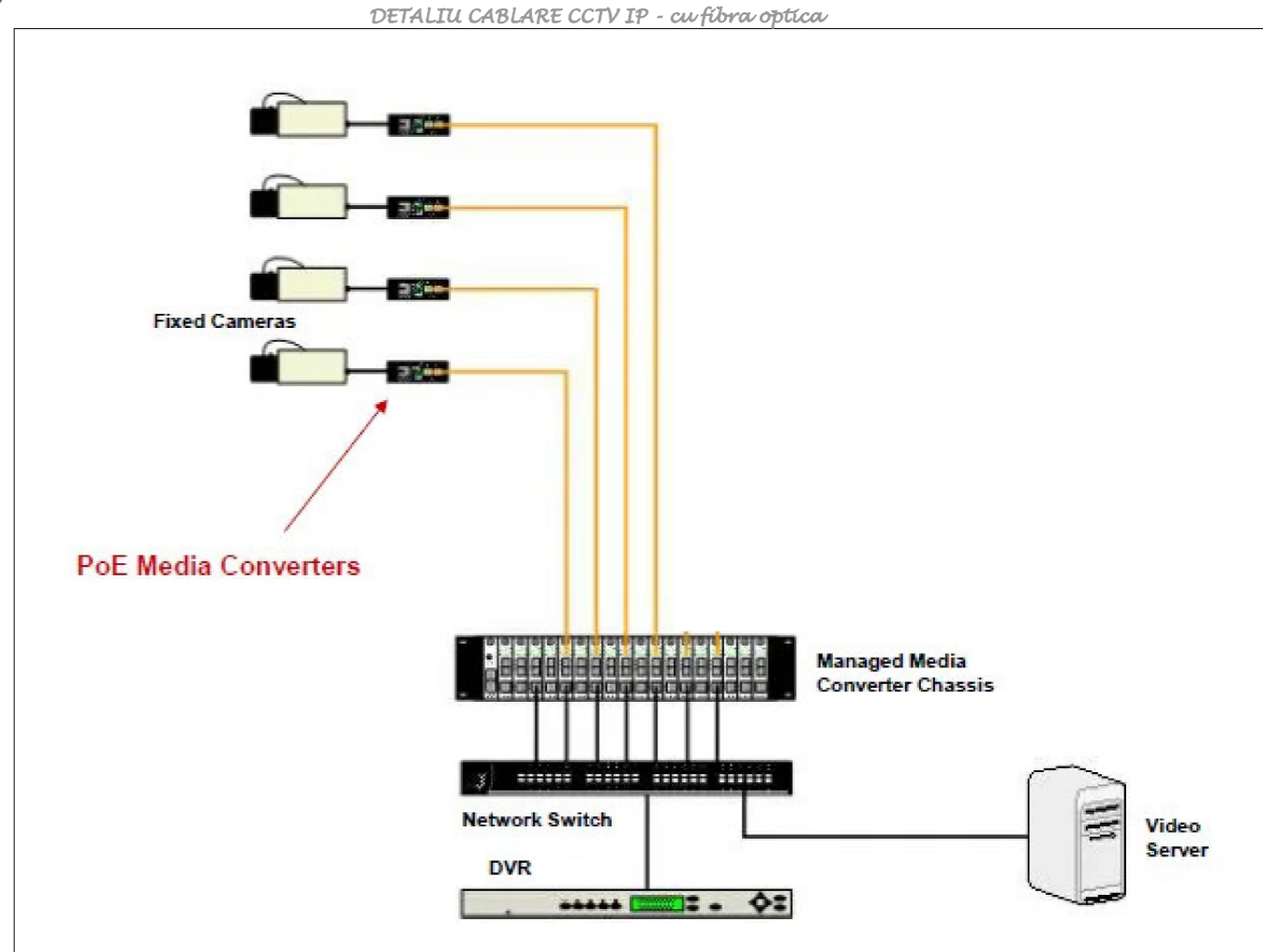
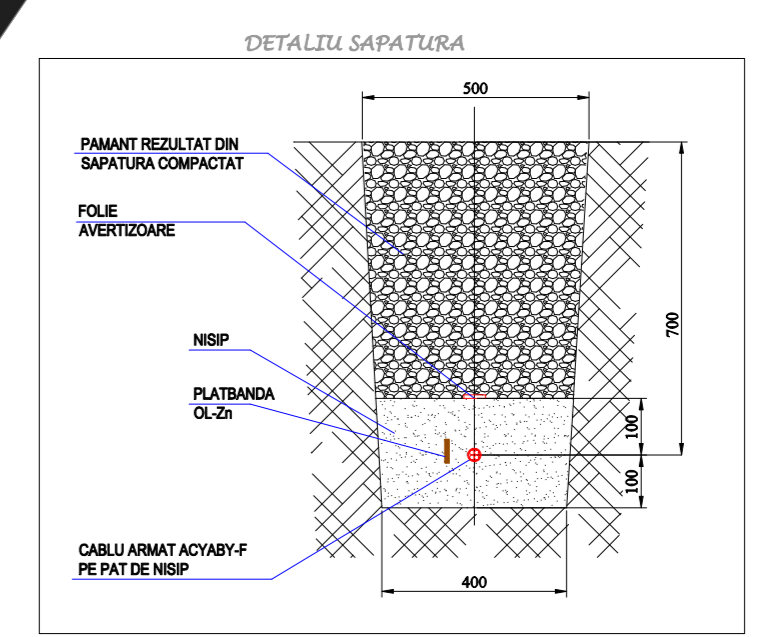
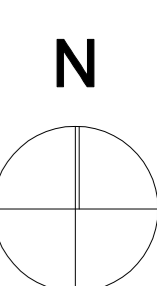
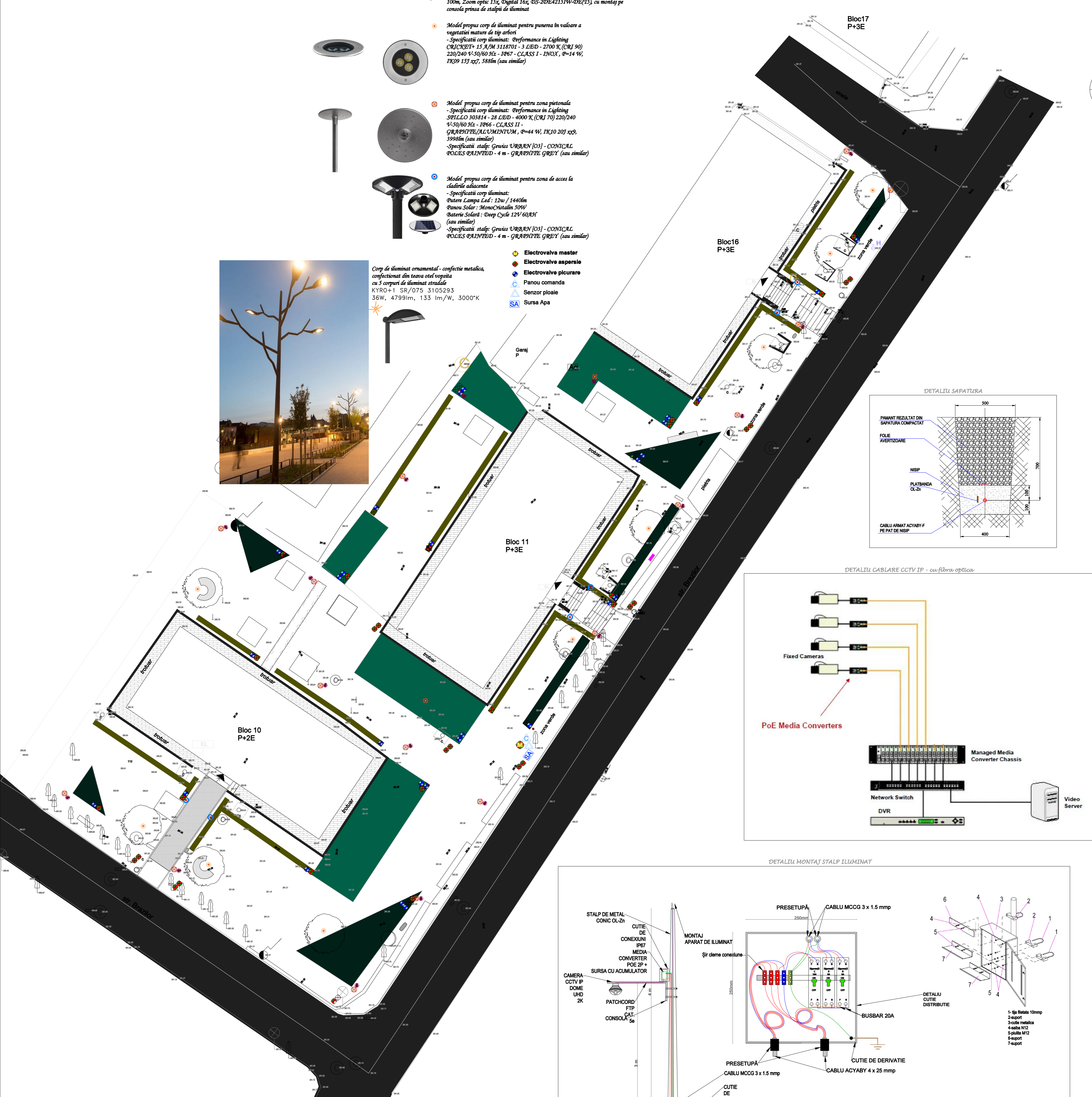
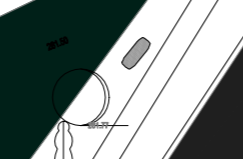
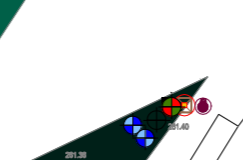
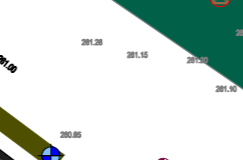
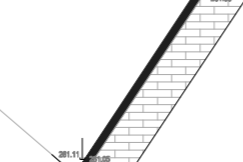
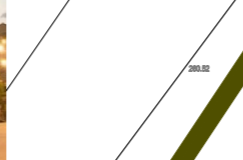
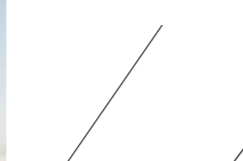

VERIFICAT				
VERIFICATOR/ EXPERT	NUME	SEMNAȚURA	CERINȚA	REFERAT / EXPERTIZĂ NR./ DATA
	PROIECTANT GENERAL:			Beneficiar: ORASUL OCNA MURES
	S.C. APULUM SOLUTIONS S.R.L. Județ Alba, Str. Alba Iulia, nr. 100A, Sibiu, nr. 34 CUIP NR. 233863320000000000 Tel. 0730.305.185, E-mail: arad@apulum.ro			
	PROIECTANT SPECIALITATE:			DENUMIRE PROIECT: OCNA MURES - VERDE. Revitalizarea și creșterea calității și atractivității spațiilor publice situate în principalele cartiere ale orașului - str. Alina Independenței, Brașov, Matrușu.
	S.C. OREZCĂ OREȘTIȘI S.R.L. Nr. O.R.C. 0280000902016, C.U.I. 86263865 Adresa: Str. Cooperatorilor, Nr. 25A, Ap. 2, Min. Sibiu, Județ Sibiu CUIP: www.orezca.ro			
SPECIFICAȚIE	NUME	SEMNAȚURA	Scara: 1:200	Faza: S.F.
ȘEF PROIECT	ing. Adela Elena RADU			
PROIECTAT	ing. Radu ENACHE			
C.A.D.	ing. Radu ENACHE		Data 11.2024	Titlu planșă PLAN DE SITUAȚIE INSTALAȚII ELECTRICE ZONA 2 - STRADA BRAZILOR - BLOCURI 10, 11, 16 - CF85458
				Planșă nr: IE-02