

Vedere din fata  
1:50

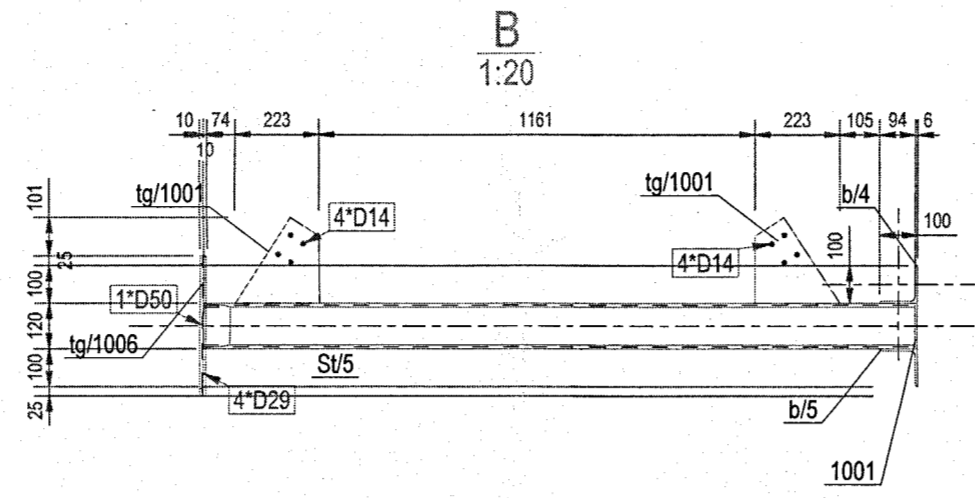

Vedere de jos  
1:20

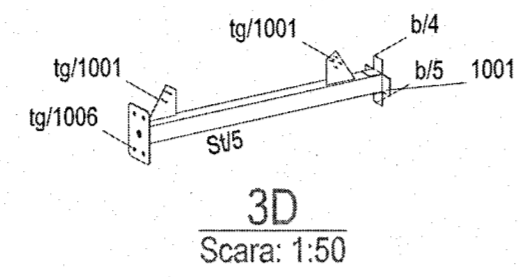
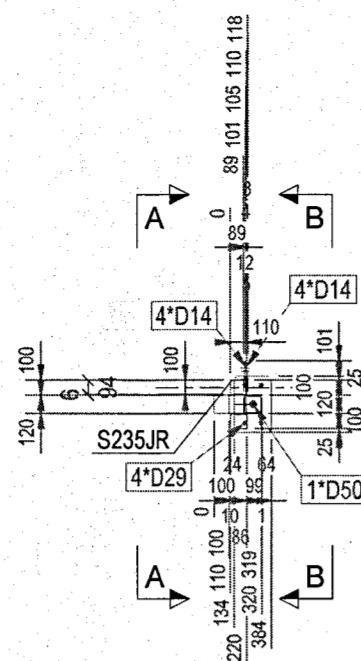
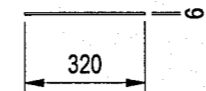

Vedere din fata  
1:20

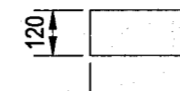

Vedere de sus  
1:20



Vedere din spate  
1:20

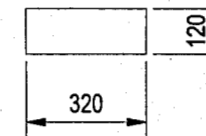

Vedere de jos  
1:20

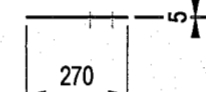

Vedere din fata  
1:20

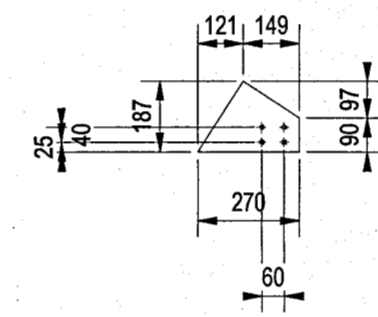

Vedere de sus  
1:20

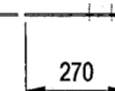

Vedere din spate  
1:20

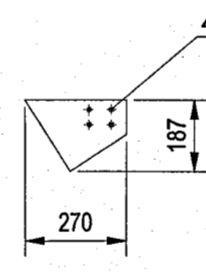

Vedere de sus  
1:50

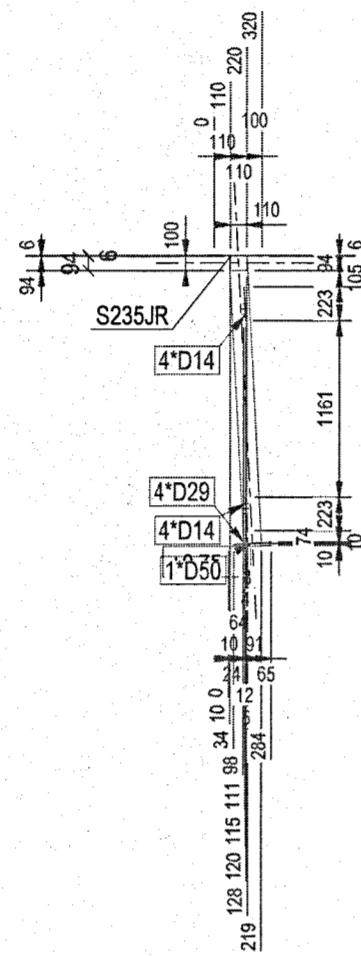

Vedere de jos  
1:20

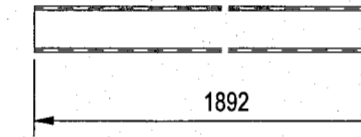

Vedere din fata  
1:20

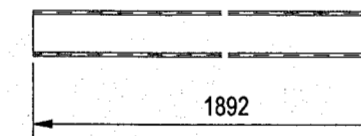

Vedere de sus  
1:20

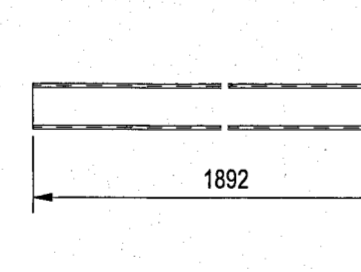

Vedere din spate  
1:20

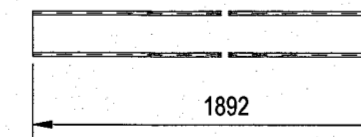

Vedere de jos  
1:20

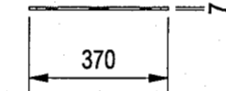

Vedere din fata  
1:20

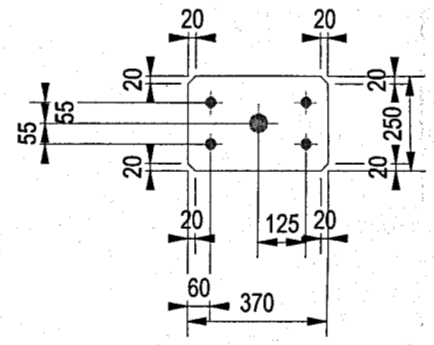

Vedere de sus  
1:20

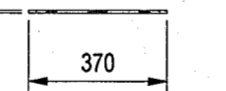

Vedere din spate  
1:20

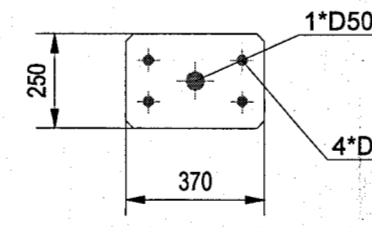

A  
1:20

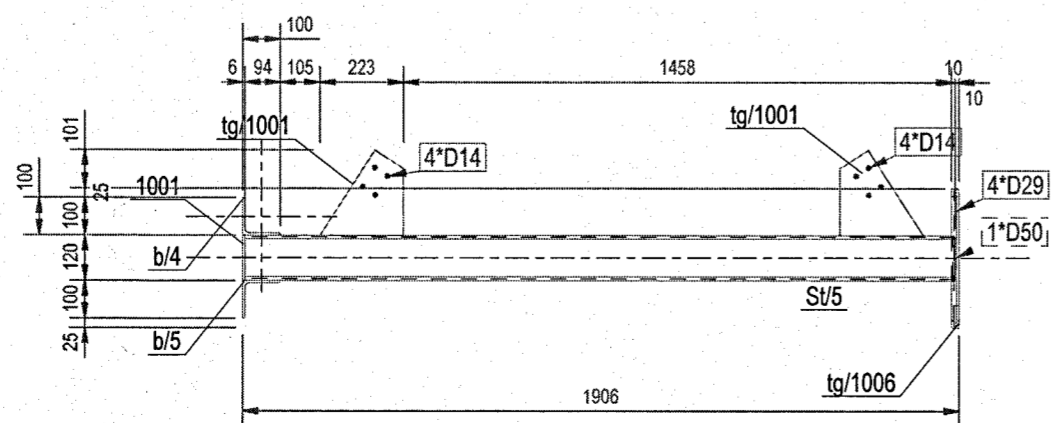

3D  
Scara: 1:20

3D  
Scara: 1:20

3D  
Scara: 1:20

3D  
Scara: 1:20

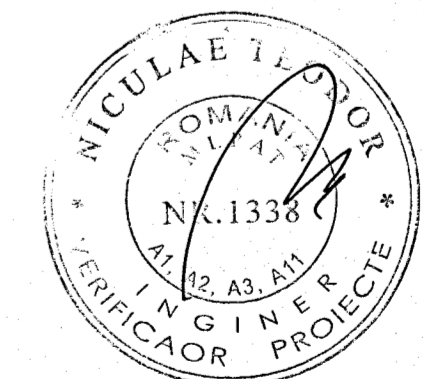

NOTE GENERALE: Suduri in relief cu grosimea de cordon de 0.7"t daca nu se specifica altfel.  
Nivel B de acceptare a sudurilor. Sudura pe toata suprafata de contact.

EXTRAS DE LAMINATE PT. ANSAMBLUL:						
Pozitie	Profil	Material	No.	Lungime	Arie	Greutate
b/4	L100*6	S235JR	1	110	0.0	1.0
1001	PL6*120	S235JR	1	320	0.1	1.8
SV/5	CFRHS120X120X5	S235JR	1	1892	0.9	33.2
b/5	L100*6	S235JR	1	110	0.0	1.0
tg/1001	PL5*187	S235JR	2	270	0.1	1.3
tg/1006	PL7*250	S235JR	1	370	0.2	5.0
Total					1.4	44.6

Proiectant structural:  
**NEO STRUCTURAL ENGINEERING SRL**  
consultanta, proiectare, expertizare structuri civile si industriale  
Adresa: Calea Bucuresti, nr. 133, Sector 6, Bucuresti

Beneficiar: **MINISTERUL AFACERILOR INTERNE**  
Adresa: Jalei Constanta, noua Manastira, satul Constanta, strada Comunisti, nr. 3-20, ICL

Sef proiect: Ing. Burciu Stefan  
Proiectat: Ing. Burciu Stefan  
Desenat: Ing. Ardelean Adrian

Denumire plansa: Ansamblul Tunel restauran [St.6]

Scara: 1:20 1:50 [St.6]  
Rev.: 0 Data: